



User Guide

HP L1755 17" & L1955 19" Flat Panel Monitors

Document Part Number: 370798-002

January 2005

This guide provides information on setting up the monitor, installing drivers, using the on-screen display menu, troubleshooting and technical specifications.

© Copyright 2005 Hewlett-Packard Development Company, L.P.
The information contained herein is subject to change without notice.

Microsoft, MS-DOS, Windows, and Windows NT are trademarks of Microsoft Corporation in the U.S. and other countries.

Intel, Pentium, Intel Inside, and Celeron are trademarks of Intel Corporation in the U.S. and other countries.

Adobe, Acrobat, and Acrobat Reader are trademarks or registered trademarks of Adobe Systems Incorporated.

The only warranties for HP products and services are set forth in the express warranty statements accompanying such products and services. Nothing herein should be construed as constituting an additional warranty. HP shall not be liable for technical or editorial errors or omissions contained herein.

This document contains proprietary information that is protected by copyright. No part of this document may be photocopied, reproduced, or translated to another language without the prior written consent of Hewlett-Packard Company.



WARNING: Text set off in this manner indicates that failure to follow directions could result in bodily harm or loss of life.



CAUTION: Text set off in this manner indicates that failure to follow directions could result in damage to equipment or loss of information.

User Guide

HP L1755 17" & L1955 19" Flat Panel Monitor

Second Edition (January 2005)

Document Part Number: 370798-002

Contents

1 Product Features

2 Safety and Maintenance Guidelines

Important Safety Information	2-1
Maintenance Guidelines	2-2
Cleaning the Monitor	2-3
Shipping the Monitor	2-3

3 Setting Up the Monitor

Installing the Monitor Base	3-1
Rear Panel Components	3-3
Selecting the Signal Connectors and Cables	3-4
Connecting the Monitor	3-4
Removing the Monitor Base	3-14
Mounting the Monitor	3-15
Locating the Rating Label	3-17

4 Operating the Monitor

Software and Utilities	4-1
The Information File	4-1
The Image Color Matching File	4-2
Installing the .INF and .ICM Files	4-2
Installing from the CD	4-2
Downloading from the Worldwide Web	4-3
Front Panel Controls	4-4
Adjusting Monitor Settings	4-5
Using the Sync-on-Green Format	4-6
Using the On-Screen Display	4-7
Adjusting Screen Quality	4-10
Optimizing Analog Video	4-10
Identifying Monitor Conditions	4-11
Sleep Timer Mode	4-12

Contents

sRGB Support	4-13
Changing the Color Temperature	4-14
Installing the sRGB ICM File for Microsoft Windows 2000 and Windows XP	4-14

A Troubleshooting

Solving Common Problems	A-1
Using the Worldwide Web	A-3
Preparing to call Technical Support	A-3

B Technical Specifications

Recognizing Preset Display Resolutions	B-4
Entering User Modes	B-5
Energy Saver Feature	B-6

C Agency Regulatory Notices

Federal Communications Commission Notice	C-1
Modifications	C-1
Cables	C-2
Declaration of Conformity for Products Marked with FCC Logo, United States Only	C-2
Canadian Notice	C-3
Avis Canadien	C-3
European Notice	C-3
Japanese Notice	C-4
Korean Notice	C-4
EPA Energy Star Compliance	C-4
Power Cord Set Requirements	C-5

D LCD Monitor Quality and Pixel Policy

Product Features

The Flat Panel Display has an active matrix, thin-film transistor (TFT), liquid crystal display (LCD). The monitor features include:

- HP L1755 model, 17-inch (43.2 cm) viewable area display, with narrow bezels.
- HP L1955 model, 19-inch (48.3 cm) viewable area display, with narrow bezels.
- 1280 × 1024 native resolution, plus full-screen support for lower resolutions.
- Wide viewing angle to allow viewing from a sitting or standing position, or moving side-to-side.
- Tilt, swivel, and height adjustment capabilities.
- Easily removable base for flexible mounting solutions.
- Multiple video inputs supported:
 - VGA Analog
 - DVI-I supports either Analog or Digital signal input (available on select models)
- VGA analog, DVI-Digital, and VGA to DVI-I signal cables included.
- USB 2.0 hub with one upstream (connects to the computer) and four downstream (connects to USB devices) ports.

- USB cable included to connect the monitor's USB hub to the USB connector on the computer.
- Mounting feature on bottom of monitor to accept an optional Speaker Bar accessory kit.
- Plug and play capability if supported by your system.
- On-Screen Display (OSD) adjustments in English, French, German, Italian, Japanese, Simplified Chinese, and Spanish for ease of set-up and screen optimization.
- Software and documentation CD includes an information file (INF), Image Color Matching file (ICM), and product documentation.
- Energy Saver feature for Energy Star compliance.
- AssetControl
- Compliant with the following regulated specifications:
 - ❑ EPA ENERGY STAR
 - ❑ European Union CE Directives
 - ❑ Swedish MPR II 1990
 - ❑ Swedish TCO

Safety and Maintenance Guidelines

Important Safety Information

A power cord is included with your monitor. If another cord is used, use only a power source and connection appropriate for this monitor. For information on the correct power cord set to use with your monitor, refer to the “Power Cord Set Requirements” section in Appendix C.



WARNING: To reduce the risk of electric shock or damage to your equipment, do not disable the power cord grounding feature. This equipment is designed to be connected to a grounded (earthed) power outlet that is easily accessible to the operator. The grounding plug is an important safety feature.



WARNING: For your safety, be sure that the power outlet you plug the power cord into is easily accessible and located as close to the equipment as possible. When you need to disconnect the power to the equipment, unplug the power cord from the power outlet by grasping the plug firmly. Never pull on the cord.



CAUTION: For the protection of your monitor, as well as your computer, connect all power cords for your computer and its peripheral devices (such as a monitor, printer, scanner) to some form of surge protection device such as a power strip or Uninterruptible Power Supply (UPS). Not all power strips provide surge protection; the power strips must be specifically labeled as having this ability. Use a power strip whose manufacturer offers a Damage Replacement Policy so you can replace your equipment if surge protection fails.

Maintenance Guidelines

To enhance the performance and extend the life of your monitor:

- Do not open your monitor cabinet or attempt to service this product yourself. Adjust only those controls that are covered in the operating instructions. If your monitor is not operating properly or has been dropped or damaged, contact your HP authorized dealer, reseller, or service provider.
- Use only a power source and connection appropriate for this monitor, as indicated on the label/back plate of the monitor.
- Be sure the total ampere rating of the products connected to the outlet does not exceed the current rating of the electrical outlet, and the total ampere rating of the products connected to the cord does not exceed the rating of the cord. Look on the power label to determine the ampere rating (AMPS or A) for each device.
- Install your monitor near an outlet that you can easily reach. Disconnect the monitor by grasping the plug firmly and pulling it from the outlet. Never disconnect the monitor by pulling the cord.
- Turn your monitor off when not in use. You can substantially increase the life expectancy of your monitor by using a screen saver program and turning off the monitor when not in use.

- Slots and openings in the cabinet are provided for ventilation. These openings must not be blocked or covered. Never push objects of any kind into cabinet slots or other openings.
- Do not drop your monitor or place it on an unstable surface.
- Do not allow anything to rest on the power cord. Do not walk on the cord.
- Keep your monitor in a well-ventilated area, away from excessive light, heat or moisture.
- When removing the monitor base, you must lay the monitor face down on a soft area to prevent it from getting scratched, defaced, or broken.

Cleaning the Monitor

1. Turn off the monitor and the computer.
2. Unplug the monitor from the wall outlet.
3. Clean the monitor plastics with a clean cloth dampened with water.
4. Clean the monitor screen with an antistatic screen cleaner.



CAUTION: Do not use benzene, thinner, ammonia, or any other volatile substances to clean your monitor or the screen. These chemicals may damage the cabinet finish as well as the screen.

Shipping the Monitor

Keep the original packing box in a storage area. You may need it later if you move or ship your monitor.

Setting Up the Monitor

To set up the monitor, ensure that the power is turned off to the monitor, computer system, and other attached devices, then follow the steps below.

Installing the Monitor Base



Do not install the base if the monitor will be used on a wall, swing arm, or other mounting fixture; instead refer to the section on “Mounting the Monitor” in this chapter.

1. Place the display on a soft cloth on your desktop or table.

2. Pull down on the quick release latch **1** on the back of the monitor.
3. Position the tabs on the monitor base with the adapter plate on the back of the display **2**. Then push the monitor base down toward the display **3** until latched into place.

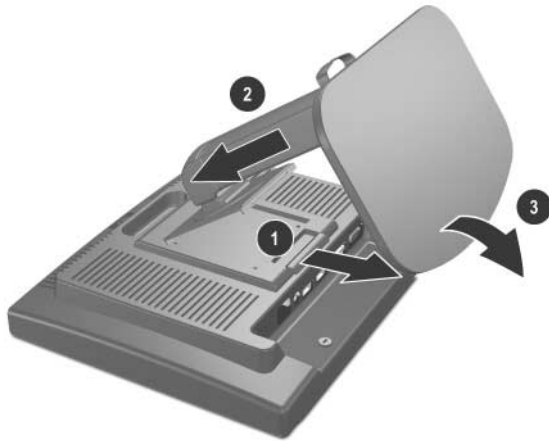

Attaching the Monitor Base

Rear Panel Components

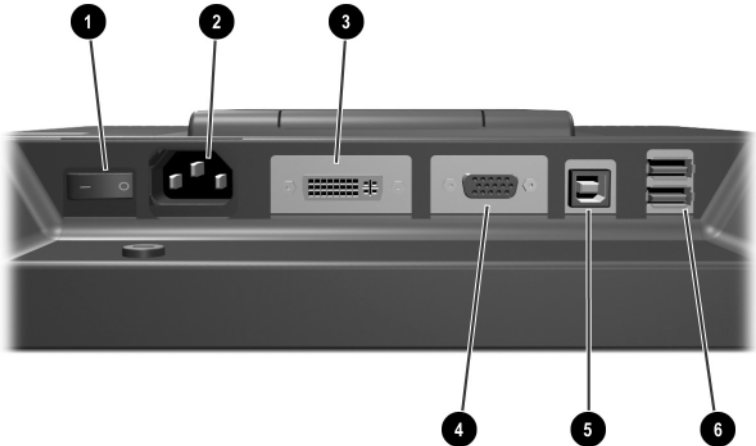

Rear Panel Components

No.	Component	Function
❶	Master Power Switch	Turns off all power to the monitor.
❷	AC Power Connector	Connects the AC power cord to the monitor.
❸	DVI Connector (available on select models)	Connects the DVI-I signal cable or DVI-D signal cable to the monitor.
❹	VGA Connector	Connects the VGA cable to the monitor.
❺	USB Upstream Connector	Connects the monitor USB hub to a host USB port/hub.
❻	USB Downstream Connectors	Connects optional USB devices to the monitor.

Selecting the Signal Connectors and Cables

There are two signal input connectors:

- VGA connector
- DVI-I connector (available on select models)

The monitor will automatically determine which inputs have valid video signals. The inputs can be selected through the On-Screen Display (OSD) feature or by pressing the – button (to enable DVI signal input) or the + button (to enable VGA signal input) on the monitor front bezel.

The video mode supported by the DVI-I connector is determined by the video cable used. For digital operation, use the DVI-D signal cable provided. For analog operation, use the VGA signal cable or VGA to DVI-I signal cable provided.

Connecting the Monitor

1. Place the monitor in a convenient, well-ventilated location near your computer.

2. For analog operation, connect one end of the VGA signal cable or the VGA to DVI signal cable to the VGA connector on the monitor and the other end to the VGA connector on the computer. For digital operation (available on select models), use the DVI-D signal cable. These cables are provided with the monitor.



Connecting the VGA Signal Cable



CAUTION: The DVI-D cable supplied with this monitor is for digital-to-digital connection only. Your computer must have a DVI-compatible graphics card installed for use with this cable. When connecting the DVI-D signal cable to the DVI connector on the monitor (available on select models), you must connect the other end of the DVI-D cable to the DVI connector on the computer.



Connecting the DVI-D Signal Cable



Connecting the VGA to DVI-I Signal Cable

3. Connect the USB cable to the USB input connector on the monitor and to a convenient USB connector on the computer.

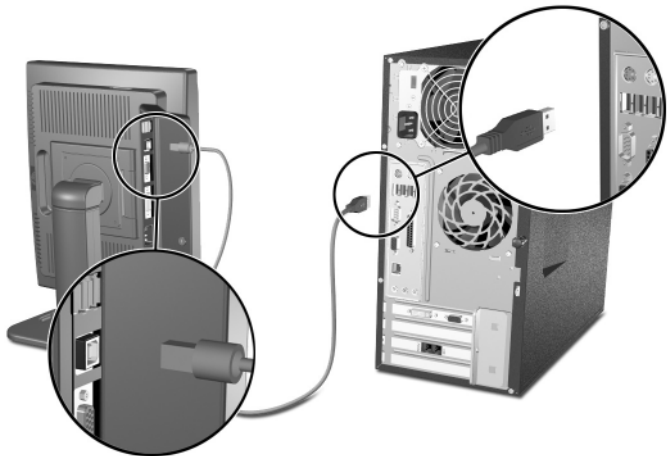

Connecting the USB Cable

4. If ready, connect the USB devices to the USB connectors on the monitor.



Connecting USB Devices

5. Connect one end of the power cable to the back of the monitor, and the other end to an electrical wall outlet.



WARNING: To reduce the risk of electric shock or damage to your equipment: Do not disable the power cord grounding plug. The grounding plug is an important safety feature.

Plug the power cord into a grounded (earthed) electrical outlet that is easily accessible at all times.

Disconnect power from the monitor by unplugging the power cord from the electrical outlet.

Do not place anything on power cords or cables. Arrange them so that no one may accidentally step on or trip over them. Do not pull on a cord or cable. When unplugging from the electrical outlet, grasp the cord by the plug.



Connecting the Power Cable

6. Adjust the monitor as needed for your comfort using the monitor's tilt, swivel, and height adjustment capabilities.

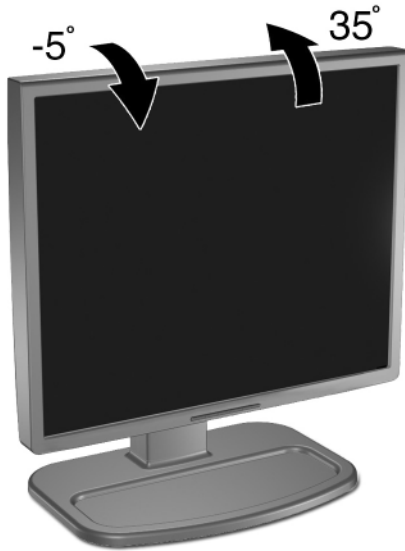

Adjusting the Tilt

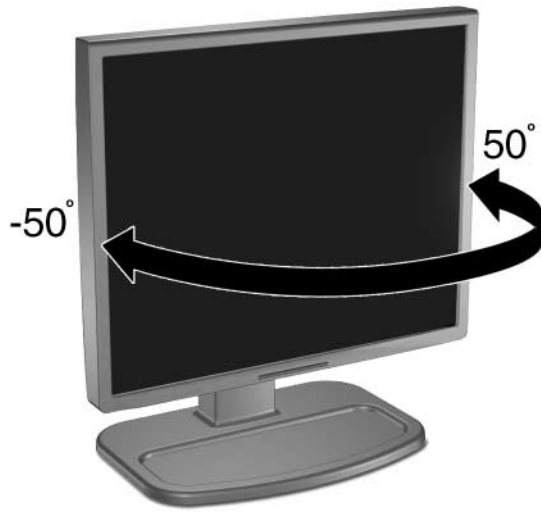

Adjusting the Swivel

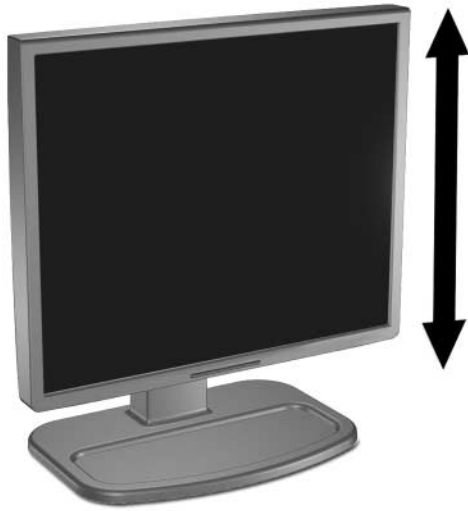

Adjusting the Height



You can change your monitor's viewing position to portrait. To rotate your display to the portrait position, you will need to install the Pivot software, which is contained on the CD included with your monitor.

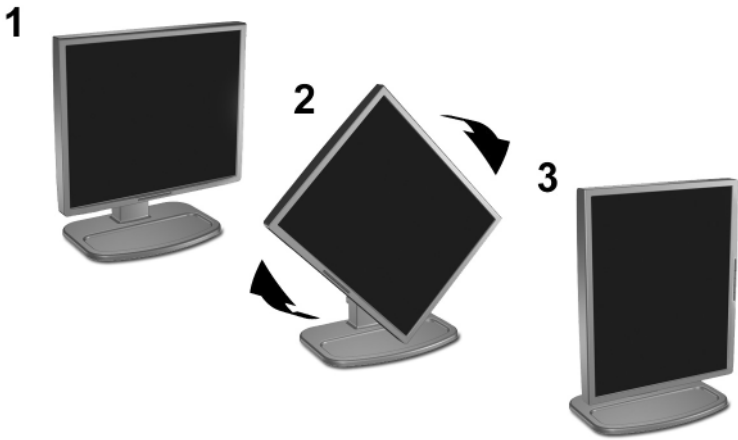

Pivoting the Monitor



CAUTION: Burn-in image damage may occur on monitors that display the same static image on screen for a prolonged period of time. To avoid burn-in image damage on your monitor screen, you should always activate a screen saver application or turn off the monitor when it is not in use for a prolonged period of time.

Removing the Monitor Base

The monitor base can be removed to mount the monitor on a wall, a swing arm or other mounting fixture. Read the caution and warning statements below before beginning the procedure.



CAUTION: Before beginning to disassemble the monitor, be sure the monitor is turned off and the power and signal cables are both disconnected.

Lay the front bezel down on a soft area to prevent it from getting scratched, defaced, or broken



WARNING: Do not remove the base from the monitor while the monitor is in the upright position. Before removing the monitor from the base, ensure that the monitor is lying flat, front bezel down, and that the base is set to the maximum base extension. Attempting to remove the monitor from the base while upright in the minimum base extension may result in injury to the user.

1. Disconnect and remove the signal and power cables from the back of the monitor.
-



CAUTION: Ensure that the bottom of the monitor base is positioned over a table or desktop before removing the base from the monitor.

2. Pull down on the quick release latch **1** on the monitor. Lift up on the monitor base **2** and pull out to remove the base **3** from the display.

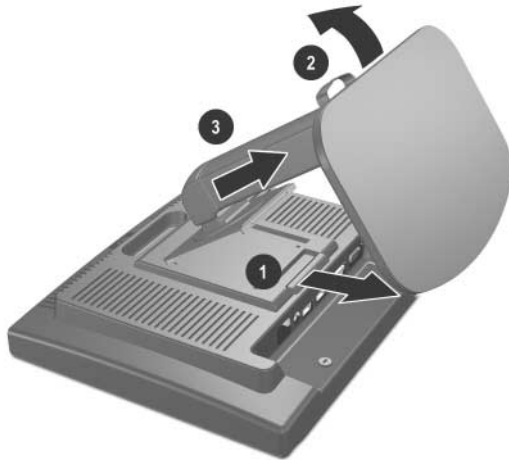

Removing the Monitor Base

Mounting the Monitor

The monitor features a quick release latch for easy installation of the display panel to a wall mounting device.

1. Remove the monitor base. Refer to “Removing the Monitor Base” steps in the previous section.
2. Remove the screws and the quick release adapter plate from the monitor base.

3. Install the adapter plate onto the swing arm or other mounting fixture using the screws removed from the monitor base.

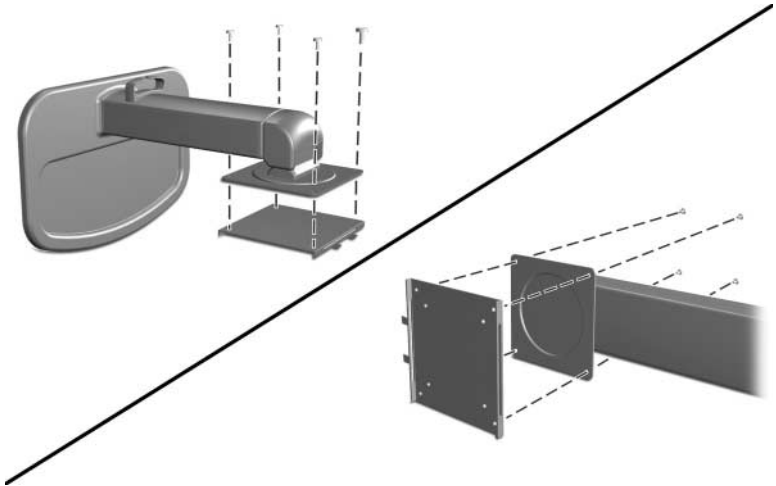

Using the Quick Release Adapter Plate to Mount the Display to a Swing Arm



For standing mounting purposes, when the base is removed, four threaded mounting holes are exposed on the display panel. These mounting holes are spaced 100 mm apart and are compliant with the Video Electronics Standards Association (VESA) standard for mounting flat panel displays.

4. Pull down the quick release latch on the back of the display panel and mount it to the adapter plate on the swing arm or other mounting fixture until it latches into place.

Locating the Rating Label

The rating label is located in the bottom, left corner on the rear panel of the monitor.



Locating the Rating Label

Operating the Monitor

Software and Utilities

The monitor includes a CD that contains two files you can install on your computer:

- an .INF (Information) file
- an .ICM (Image Color Matching) file

Adobe Acrobat Reader is supplied on this CD and can be installed from the menu.



If the monitor does not include a CD, the .INF and .ICM files can be downloaded from the HP monitors support Web site. See “Downloading from the Worldwide Web” in this chapter.

The Information File

The .INF file enables the computer to communicate with the monitor and use all the monitor features. The .INF file defines monitor resources used by Microsoft Windows operating systems to ensure monitor compatibility with the computer’s graphics adapter.

This monitor is Windows Plug and Play compatible and the monitor will work correctly without installing the .INF file. Monitor Plug and Play compatibility requires that the computer’s graphic card is VESA DDC2 compliant and that the monitor connects directly to the graphics card. Plug and Play does not

work through separate BNC type connectors or through distribution buffers/boxes. You may need to install the .INF file if these conditions are not met.

The Image Color Matching File

The .ICM file provides accurate color representation. The .ICM files are data files that are used in conjunction with graphics programs to provide consistent color matching from monitor screen to printer, or from scanner to monitor screen. The .ICM file contains a monitor color system profile. This file is activated from within graphics programs that support this feature.



The ICM color profile is written in accordance with the International Color Consortium (ICC) Profile Format specification.

Installing the .INF and .ICM Files

After you determine that you need to update, you can install the .INF and .ICM files from the CD or download them.

Installing from the CD

To install the .INF and .ICM files on the computer from the CD:

1. Insert the CD in the computer CD-ROM drive. The CD menu displays.
2. View the “INF and ICM Readme” file.
3. Select “Install INF and ICM Files.”
4. Follow the on-screen instructions.
5. After the INF software has been installed, restart Windows.

6. Ensure that the proper resolution and refresh rates appear in the Windows Display control panel.



You may need to install the digitally signed monitor .INF and .ICM files manually from the CD in the event of an installation error. Refer to the INF and ICM Readme file on the CD.

Downloading from the Worldwide Web

To download the latest version of .INF and .ICM files from the HP monitors support Web site:

1. Refer to <http://www.hp.com/support> and select your country region.
2. Follow the links for your monitor to the support page and download page.
3. Ensure your system meets the requirements.
4. Download the software by following the instructions.

Front Panel Controls

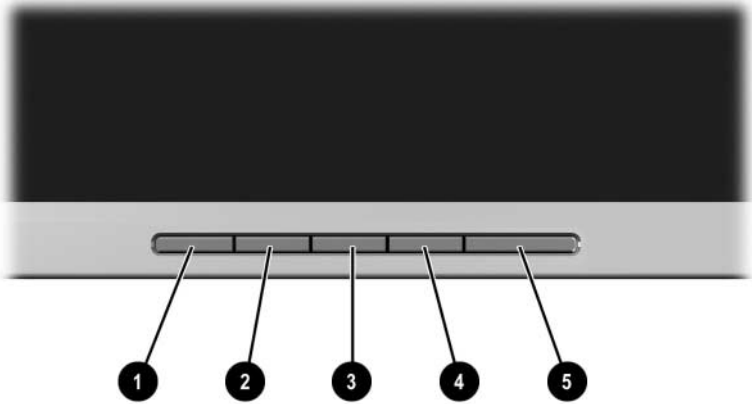

Front Panel Controls

No.	Control	Function
❶	Auto Adjust	Activates the auto adjustment feature for optimum image.
❷	Menu	Opens the On-Screen Display (OSD) menu.
❸	- (Minus)	<ul style="list-style-type: none">• If OSD is on, press to navigate backward through the OSD menu features and decrease adjustment levels.• If OSD is off, press to enable the DVI signal input (available on select models)
❹	+ (Plus)	<ul style="list-style-type: none">• If OSD is on, press to navigate forward through the OSD menu features and increase adjustment levels.• If OSD is off, press to enable the VGA signal input.
❺	Power	Turns the monitor on or off.

Adjusting Monitor Settings

Use the On-Screen Display (OSD) to adjust the screen image based on your viewing preferences. To access the OSD, do the following:

1. If the monitor is not already on, press the Power switch to turn on the monitor.
2. Press the Menu button on the monitor's front panel to launch the OSD Main Menu.



3. To navigate through the OSD Menu, press the + (Plus) button on the monitor's front panel to scroll up, or the - (Minus) button to scroll in reverse.

4. To select an item from the OSD Menu, use the + or – buttons to scroll to and highlight your selection, then press the Menu button to select that function.
5. Adjust the item using the + or – buttons on the front panel to adjust the scale.
6. After adjusting the function, select Save and Return, or Cancel if you don't want to save the setting, then select Exit from the Main Menu.



If the buttons remain untouched for 10 seconds while displaying a menu, new adjustments will be discarded and the settings will revert to the previous settings and exit the menu.

Using the Sync-on-Green Format

If you require use of the sync-on-green video format, you must enable this format through the Main On-Screen Display Menu.

1. Press the Menu button on the front panel of the monitor to activate the Main (Advanced) OSD Menu.
2. Select Management.
3. Select Sync-on-Green. Then select On.
4. Select Save and Return. Then Exit the OSD Menu.

Using the On-Screen Display

There are two On-Screen Display menus available; one for basic adjustments, and one for advanced adjustments.

To access the Basic OSD Menu, press the menu button on the monitor's front panel.

Basic OSD Menu Levels	
Menu Level 1	Menu Level 2
Brightness	Adjustment Scale
Contrast	Adjustment Scale
Auto Adjustment	
Advanced Menu	
Exit	

To access the Advanced OSD Menu, press the menu button again, or select Advanced Menu from the Basic OSD Menu.



After selecting the Advanced Menu from the Basic Menu, the Advanced Menu remains the default OSD on subsequent power-ups of the monitor until the Basic Menu is selected or Factory Reset is applied.

The Advanced OSD Menu has up to three sublevels and can be viewed in one of seven available languages. The following table provides the menus and their functions at each level:

Advanced OSD Menu Levels				
Level 1	Level 2	Level 3	Factory Preset	
Brightness	Adjustment Scale		Y	
Contrast	Adjustment Scale		Y	
Image Control	Auto Adjustment	"Adjusting" Message	Y	
	Horizontal Position	Adjustment Scale	Y	
	Vertical Position	Adjustment Scale	Y	
	Sharpness	Adjustment Scale	Y	
	Clock	Adjustment Scale	Y	
	Clock Phase	Adjustment Scale	Y	
	Cancel			
	Save and Return			
	Color	9300 K		
6500 K			Y	
Custom Color		Custom Color Adjustment		
sRGB				
Cancel				
Save and Return				
Language		Deutsch		
		English		
		Espanol		N
	Francais			
	Italiano			
	Japanese			
	S. Chinese			
	Cancel			
	Save and Return			
Management	Power Saver	On / Off Selection	N	
	Power On Recall	On / Off Selection	N	
	Mode Display	On / Off Selection	N	

Advanced OSD Menu Levels (Continued)

Level 1	Level 2	Level 3	Factory Preset
	Power On Status Display	On / Off Selection	N
	Sleep Timer	Timer Set Menu	N
	Default Video Input	-Analog - VGA	N
		Digital - DVI	
	Serial Number	Display monitor s/n	
	Basic Menu		N
	Sync-on-Green	On / Off Selection	Off
	Cancel		
	Save and Return		
OSD Control	Horizontal OSD Position	Adjustment Scale	N
	Vertical OSD Position	Adjustment Scale	N
	OSD Timeout	Adjustment Scale	N
	Cancel		
	Save and Return		
Information	Yes		
Factory Reset	Yes		
	No		
Exit			

Adjusting Screen Quality

Allow the monitor to warm up for 20 minutes before performing the following procedures.

The Auto-adjustment feature automatically fine-tunes the image quality each time a new video mode is utilized. If additional improvement is desired, press the Auto adjust button on the front bezel.

For more precise adjustments, use the adjustment pattern provided on the CD-ROM, and adjust the clock and phase settings (accessed from the OSD menu) as described in the following section.

Optimizing Analog Video

This monitor contains advanced circuitry that allows the flat panel screen to function like a standard monitor. Two controls in the on-screen display can be adjusted to improve image performance: Clock and Clock Phase. Use these controls only when the auto-adjust function does not provide a satisfactory image.



The Clock must first be set correctly since the Clock Phase settings are dependent on the main Clock setting.

- Clock—Increase/decrease the value to minimize any vertical bars or stripes visible on the screen background.
 - Clock Phase—Increase/decrease the value to minimize video distortion or video jitter.
-



When using the controls, you will obtain the best results by using the adjustment pattern application provided on the CD-ROM.



When adjusting the Clock and Clock Phase values, if the monitor images become distorted, continue adjusting the values until the distortion disappears. To restore the factory settings, select Yes from the Factory Reset menu in the on-screen display.

Identifying Monitor Conditions

Special messages will appear on the monitor screen when identifying the following monitor conditions:

- **Input Signal Out of Range**— Indicates the monitor does not support the input signal because the resolution and/or refresh rate are set higher than the monitor supports. Set the resolution and refresh rate for 1280 x 1024 at 60 Hz. Restart your computer for the new settings to take effect.
- **Monitor Going to Sleep**— Indicates the screen display is entering a sleep mode.
- **Check Video Cable**— Indicates the video cable is not properly connected to the computer.
- **OSD Lock**—The OSD can be enabled or disabled by pressing and holding the Menu button on the front panel for 10 seconds. If the OSD is locked, the warning message “OSD Lock” displays for ten seconds.
 - If the OSD is locked, press and hold the Menu button for 10 seconds to unlock the OSD.
 - If the OSD is unlocked, press and hold the Menu button for 10 seconds to lock the OSD.

Sleep Timer Mode

The Sleep Timer mode is an energy-saving feature that enables you to set a time for the monitor to power on and off at the same time every day. This also extends the life of the backlight bulbs in the monitor. The Sleep Timer has five settings:

- Set Current Time
- Set Sleep Time
- Set On Time
- Timer: On/Off
- Sleep Now

To set the timer:

1. Press the Menu button on the monitor front panel to display the Advanced Menu.
2. Scroll down and highlight Management.
3. Press the Menu button to select Management.
4. Scroll down and highlight and select Sleep Timer > Set Current Time.



You must set the current local time before you reset the time for Sleep Time or On Time. Note that the time is displayed in a 24 hour clock format. For example, 1:15 p.m. displays as 13 hours 15 minutes.

5. Press the Menu button once to enter the adjustment mode for hours.
6. Press the - (Minus) or + (Plus) buttons to adjust the hour.
7. Press the Menu button again to enter the time for minutes.
8. Press the - (Minus) or + (Plus) buttons to adjust the minutes.

9. Press the Menu button to lock in the time chosen.
10. After setting the current time, the highlight automatically skips to Set Sleep Time hours. Repeat steps 6 through 9 to set Sleep Time.
11. If you do not want to set Sleep Time, press the Menu button twice, then select Save and Return to exit the menu.
12. After setting Sleep Time, the highlight automatically skips to Set On Time hours. Repeat steps 6 through 9 to set On Time.
13. Set the Timer mode to On to activate the Sleep Timer settings.
14. When you are finished, select Save and Return to exit the menu.

The fifth selection, Sleep Now, turns the monitor backlights off immediately and stays in sleep mode until the next On Time activates or a monitor button is pressed.

sRGB Support

The monitor is designed to support sRGB for color management, which adapts to the color standards used in the image technology industry. Additional information on sRGB is available on <http://www.srgb.com/srgb.html> (English only).

To take advantage of the sRGB support, you will need to change your monitor's color temperature to sRGB and install the sRGB color profile (ICM) file.



The sRGB color temperature preset will improve the color accuracy of sRGB images on the computer monitor, but some color variation may still occur.

Changing the Color Temperature

1. Press the Menu button on the front panel of the monitor to launch the Main Menu of the OSD.
2. Select Advanced Menu to access all options in the Main Menu.
3. Select Color to display the Color Temperature menu.
4. Select sRGB.
5. Select Save and Return to exit the menu.

Installing the sRGB ICM File for Microsoft Windows 2000 and Windows XP



To complete the following procedure, you must be logged in as an administrator or a member of the administrator's group. If the computer is connected to a network, network policy settings may prevent you from completing this procedure.

The sRGB ICM file does not support Windows 95 and Windows NT operating systems

1. Click the Display icon in the Control Panel.
2. In the Display Properties windows, select the **Settings** tab, then click the **Advanced** button.

3. Select the **Color Management** tab, then click the **Add** button to open the Add Profile Association dialog box.
4. Select the “sRGB Color Space Profile.icm” file, then click the **Add** button
5. To activate a color profile for your monitor, you must set it as the Default Monitor Profile. Select “sRGB Color Space Profile,” then click **Set as Default** button.
6. Click **Apply** or **OK**.

A

Troubleshooting

Solving Common Problems

The following table lists possible problems, the possible cause of each problem, and the recommended solutions.

Problem	Possible Cause	Solution
Screen is blank.	Power cord is disconnected.	Connect the power cord.
	Power switch on front panel of the monitor is turned off.	Press the front panel power button.
	Master power switch on rear panel of the monitor is turned Off.	Turn the master power switch to On.
	Video cable is improperly connected.	Connect the video cable properly. Refer to <i>Chapter 3, Setting Up the Monitor</i> , for more information.
	Screen blanking utility is active.	Press any key on the keyboard or move the mouse to inactivate the screen blanking utility.

Problem	Possible Cause	Solution
Image appears blurred, indistinct, or too dark.	Brightness and contrast are too low.	Press the Auto Adjust button on the front panel. If this does not correct the image, press the Menu button to open the Basic OSD Menu, and adjust the brightness and contrast scales as needed.
Image is not centered.	Position may need adjustment.	Press the Menu button to access the OSD menu. Select Image Control/Horizontal Position or Vertical Position to adjust the horizontal or vertical position of the image.
"No Connection, Check Signal Cable" is displayed on screen.	Monitor video cable is disconnected.	Connect the 15-pin monitor video cable to the VGA connector on the computer, the DVI-D signal cable to the DVI connector on the computer, or the VGA to DVI-I cable to the VGA connector on the computer. Be sure that the computer power is off while connecting the video cable.
"Out of Range. Set Monitor to 1280 x 1024 @ 60Hz" is displayed on screen.	Video resolution and/or refresh rate are set higher than what your monitor supports.	Restart your computer and enter Safe Mode. Change your settings to a supported setting (see "Factory Preset Display Modes" table in Appendix B). Restart your computer so that the new settings take effect.

Using the Worldwide Web

For online access to technical support information, self-solve tools, online assistance, community forums of IT experts, broad multivendor knowledge base, monitoring and diagnostic tools, go to: <http://www.hp.com/support>.

Preparing to call Technical Support

If you cannot solve a problem using the troubleshooting tips in this section, you may need to call technical support. Have the following information available when you call:

- The monitor
- Monitor model number
- Serial number for the monitor
- Purchase date on invoice
- Conditions under which the problem occurred
- Error messages received
- Hardware configuration
- Hardware and software you are using

Technical Specifications



All performance specifications are provided by the component manufacturers. Performance specifications represent the highest specification of all HP's component manufacturers' typical level specifications for performance and actual performance may vary either higher or lower.

L1755 Flat Panel Monitor

Display Type	17.0 inches TFT LCD	43.2 cm
Viewable Image Size	17.0-inch diagonal	43.2 cm
Brightness	250 cd/m ²	
Contrast Ratio	Up to 1000 to 1	
Tilt	-5 to 35°	
Swivel	-50 to 50°	
Face Treatment	Anti-glare polarizer with hard coating	
Maximum Weight (Unpacked, base attached)	14.8 lbs.	6.7 kg

L1755 Flat Panel Monitor (Continued)

Dimensions

(include pedestal)

Height (bottom of height adjust range) 16.1 inches 409 mm

Depth 8.3 inches 210 mm

Width 14.4 inches 365 mm

Maximum Graphics Resolution 1280 x 1024 (75 Hz) analog and digital modes

Text Mode 720 x 400

Dot Pitch 0.264 x 0.264 mm

Horizontal Frequency (analog mode) 30 to 82 kHz

Vertical Refresh Rate (analog mode) 56 to 76 Hz

Environmental Requirements

Temperature:

Operating Temperature 41 to 95° F 5 to 35° C

Non-operating Temperature -4 to 140° F -20 to 60° C

Relative Humidity 20 to 80%

Power Source 100 - 240 VAC, 60-50 Hz

Power Consumption <40 watts typical

Input Terminals 15-pin D-type connector with cable included.
DVI-I connector (available on select models) with DVI-D cable and VGA to DVI cable included

L1955 Flat Panel Monitor

Display Type	19.0 inches TFT LCD	48.3 cm
Viewable Image Size	19.0-inch diagonal	48.3 cm
Brightness	250 cd/m ²	
Contrast Ratio	Up to 1000 to 1	
Tilt	-5 to 35°	
Swivel	-50 to 50°	
Face Treatment	Anti-glare polarizer with hard coating	
Maximum Weight (Unpacked, base attached)	16.5 lbs.	7.5 kg
Dimensions (include pedestal)		
Height (bottom of height adjust range)	16.8 inches	426 mm
Depth	8.3 inches	210 mm
Width	15.9 inches	404 mm
Maximum Graphics Resolution	1280 x 1024 (75 Hz) analog and digital modes	
Text Mode	720 x 400	
Dot Pitch	0.294 x 0.294 mm	
Horizontal Frequency (analog mode)	30 to 82 kHz	
Vertical Refresh Rate (analog mode)	56 to 76 Hz	

L1955 Flat Panel Monitor (Continued)

Environmental Requirements

Temperature:

Operating Temperature	41 to 95° F	5 to 35° C
Non-operating Temperature	-4 to 140° F	-20 to 60° C

Relative Humidity 20 to 80%

Power Source 100 - 240 VAC, 60-50 Hz

Power Consumption <40 watts typical

Input Terminals 15-pin D-type connector with cable included.
DVI-I connector with DVI-D cable and VGA to DVI
cable included

Recognizing Preset Display Resolutions

The display resolutions listed below are the most commonly used modes and are set as factory defaults. This monitor automatically recognizes these preset modes and they will appear properly sized and centered on the screen.

Factory Preset Display Modes

Preset	Pixel Format	Horz Freq (kHz)	Vert Freq (Hz)
1	640 x 480	31.5	60.0
2	640 x 480	37.9	73.0
3	640 x 480	37.5	75.0
4	720 x 400	31.5	70.0
5	800 x 600	37.9	60.0

Factory Preset Display Modes (Continued)

Preset	Pixel Format	Horz Freq (kHz)	Vert Freq (Hz)
6	800 x 600	48.1	72.0
7	800 x 600	46.9	75.0
8	832 x 624	49.7	75.0
9	1024 x 768	48.4	60.0
10	1024 x 768	56.5	70.0
11	1024 x 768	60.0	75.0
12	1152 x 870	68.7	75.0
13	1152 x 900	71.7	76.0
14	1280 x 1024	64.0	60.0
15	1280 x 1024	80.0	75.0

Entering User Modes

The video controller signal may occasionally call for a mode that is not preset if:

- You are not using a standard graphics adapter.
- You are not using a preset mode.

If this occurs, you may need to readjust the parameters of the monitor screen by using the on-screen display. Your changes can be made to any or all of these modes and saved in memory. The monitor automatically stores the new setting, then recognizes the new mode just as it does a preset mode. In addition to the 15 factory preset modes, there are four user modes that can be entered and stored.

Energy Saver Feature

When the monitor is in its normal operating mode, the monitor uses less than 40 watts of power and the Power light is green.

The monitor also supports a reduced power state. The reduced power state will be entered into if the monitor detects the absence of either the horizontal sync signal and/or the vertical sync signal. Upon detecting the absence of these signals, the monitor screen is blanked, the backlight is turned off, and the Power light is turned amber. When the monitor is in the reduced power state, the monitor will utilize less than 2 watts of power. There is a brief warm up period before the monitor will return to its normal operating mode.

Refer to your computer manual for instructions on setting energy saver features (sometimes called power management features).



The above energy saver feature only works when connected to computers that have energy saver features.

By selecting settings in the monitor's Energy Saver utility, you can also program the monitor to enter into the reduced power state at a predetermined time. When the monitor's Energy Saver utility causes the monitor to enter the reduced power state, the Power light blinks amber.

Agency Regulatory Notices

Federal Communications Commission Notice

This equipment has been tested and found to comply with the limits for a Class B digital device, pursuant to Part 15 of the FCC Rules. These limits are designed to provide reasonable protection against harmful interference in a residential installation. This equipment generates, uses, and can radiate radio frequency energy and, if not installed and used in accordance with the instructions, may cause harmful interference to radio communications. However, there is no guarantee that interference will not occur in a particular installation. If this equipment does cause harmful interference to radio or television reception, which can be determined by turning the equipment off and on, the user is encouraged to try to correct the interference by one or more of the following measures:

- Reorient or relocate the receiving antenna.
- Increase the separation between the equipment and the receiver.
- Connect the equipment into an outlet on a circuit different from that to which the receiver is connected.
- Consult the dealer or an experienced radio or television technician for help.

Modifications

The FCC requires the user to be notified that any changes or modifications made to this device that are not expressly approved by Hewlett Packard Company may void the user's authority to operate the equipment.

Cables

Connections to this device must be made with shielded cables with metallic RFI/EMI connector hoods to maintain compliance with FCC Rules and Regulations.

Declaration of Conformity for Products Marked with FCC Logo, United States Only

This device complies with Part 15 of the FCC Rules. Operation is subject to the following two conditions: (1) this device may not cause harmful interference, and (2) this device must accept any interference received, including interference that may cause undesired operation.

For questions regarding your product, contact:

Hewlett Packard Company
P. O. Box 692000, Mail Stop 530113
Houston, Texas 77269-2000

Or, call

1-800- 652-6672

For questions regarding this FCC declaration, contact:

Hewlett Packard Company
P. O. Box 692000, Mail Stop 510101
Houston, Texas 77269-2000

Or, call

(281) 514-3333

To identify this product, refer to the Part, Series, or Model number found on the product.

Canadian Notice

This Class B digital apparatus meets all requirements of the Canadian Interference-Causing Equipment Regulations.

Avis Canadien

Cet appareil numérique de la classe B respecte toutes les exigences du Règlement sur le matériel brouilleur du Canada.

European Notice

Products with the CE Marking comply with both the EMC Directive (89/336/EEC) and the Low Voltage Directive (73/23/EEC) issued by the Commission of the European Community.

Compliance with these directives implies conformity to the following European Norms (in brackets are the equivalent international standards):

- EN55022 (CISPR 22) - Electromagnetic Interference
- EN55024 (IEC61000-4-2,3,4,5,6,8,11) - Electromagnetic Immunity
- EN61000-3-2 (IEC61000-3-2) – Power Line Harmonics
- EN61000-3-3 (IEC61000-3-3) – Power Line Flicker
- EN60950 (IEC950) - Product Safety

Japanese Notice

この装置は、情報処理装置等電波障害自主規制協議会（VCCI）の基準に基づくクラスB情報技術装置です。この装置は、家庭環境で使用することを目的としていますが、この装置がラジオやテレビジョン受信機に近接して使用されると、受信障害を引き起こすことがあります。

取扱説明書に従って正しい取り扱いをして下さい。

Korean Notice

B급 기기 (가정용 정보통신기기)

이 기기는 가정용으로 전자파적합등록을 한 기기로서
주거지역에서는 물론 모든지역에서 사용할 수 있습니다.

EPA Energy Star Compliance

Monitors that are marked with the Energy Star Logo meet the requirements of the EPA Energy Star program. As an Energy Star Partner, Hewlett Packard Company has determined that this product meets the Energy Star guidelines for energy efficiency. Specific details on using the Energy Saving features can be found in the energy saver or power management section of the computer manual.

Power Cord Set Requirements

The monitor power supply is provided with Automatic Line Switching (ALS). This feature allows the monitor to operate on input voltages between 100-120V or 200-240V.

The power cord set (flexible cord or wall plug) received with the monitor meets the requirements for use in the country where you purchased the equipment.

If you need to obtain a power cord for a different country, you should purchase a power cord that is approved for use in that country.

The power cord must be rated for the product and for the voltage and current marked on the product's electrical ratings label. The voltage and current rating of the cord should be greater than the voltage and current rating marked on the product. In addition, the cross-sectional area of the wire must be a minimum of 0.75 mm² or 18AWG, and the length of the cord must be between 6 feet (1.8 m) and 12 feet (3.6 m). If you have questions about the type of power cord to use, contact your HP authorized service provider.

A power cord should be routed so that it is not likely to be walked on or pinched by items placed upon it or against it. Particular attention should be paid to the plug, electrical outlet, and the point where the cord exits from the product.

For use in Japan:

- Please use the power cord received with the product.
- The power cord received with this product is not for use with other products.

LCD Monitor Quality and Pixel Policy

The TFT monitor uses high-precision technology, manufactured according to HP standards, to guarantee trouble-free performance. Nevertheless, the display may have cosmetic imperfections that appear as small bright or dark spots. This is common to all LCD displays used in products supplied by all vendors and is not specific to the HP LCD. These imperfections are caused by one or more defective pixels or sub-pixels.

- A pixel consists of one red, one green, and one blue sub-pixel.
- A defective whole pixel is always turned on (a bright spot on a dark background), or it is always off (a dark spot on a bright background). The first is the more visible of the two.
- A defective sub-pixel (dot defect) is less visible than a defective whole pixel and is small and only visible on a specific background.

The HP display does not have more than:

- 3 bright dots.
- 5 dark dots.
- 5 total bright and dark dots.
- No more than two adjacent (less than 25 mm edge-to-edge) defective pixels.

To locate defective pixels, the monitor should be viewed under normal operating conditions, in normal operating mode at a supported resolution and refresh rate, from a distance of approximately 50 cm (16 in.).

HP expects that, over time, the industry will continue to improve its ability to produce LCDs with fewer cosmetic imperfections and HP will adjust guidelines as improvements are made.